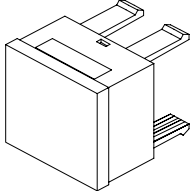
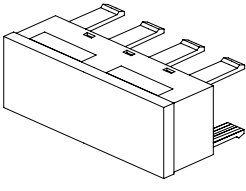
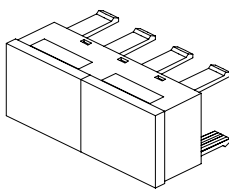
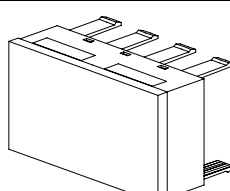
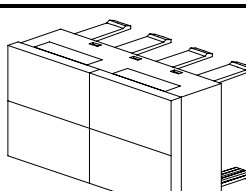
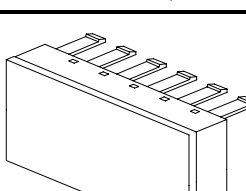
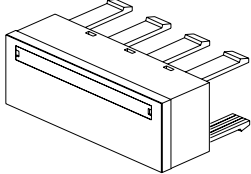
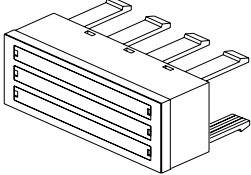
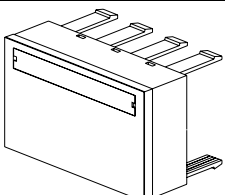
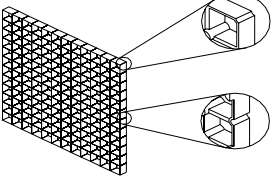
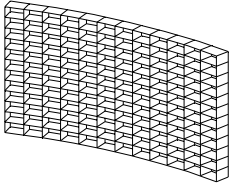
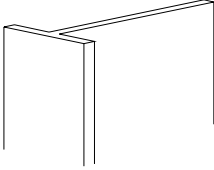
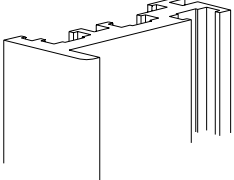
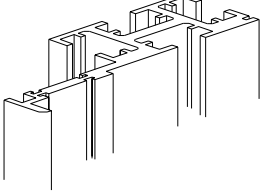
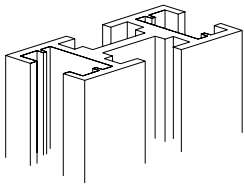
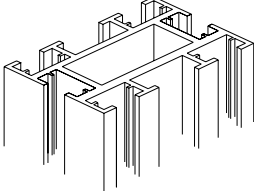
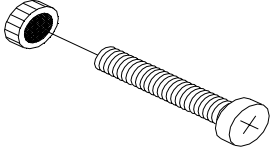
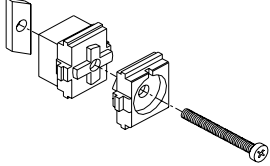
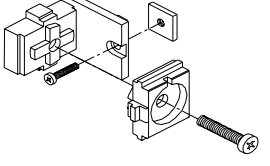
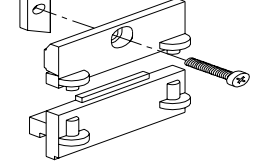
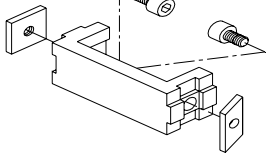
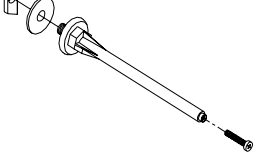

Mosaic System SM24	Mosaic Tiles			
Figure	Part No.	Description	Weight (g)	
	<b>24 x 24mm Tile</b>			
	ST-2424-GR	gray -RAL 7035	3.6	
	ST-2424-IV	ivory -RAL 1015	3.6	
	ST-2424-GN	green-RAL-6019	3.6	
	ST-2424-CH	charcoal-RAL 7016	3.6	
	ST-2424-BG	beige	3.6	
	ST-2424-WT	white translucent	3.6	
	ST-2424-RT	red translucent	3.6	
	<b>24 x 48mm Tile</b>			
	ST-2448-GR	gray	6.7	
	ST-2448-IV	ivory	6.7	
	ST-2448-GN	green	6.7	
	ST-2448-CH	charcoal	6.7	
	ST-2448-BG	beige	6.7	
	ST-2448-WT	white translucent	6.7	
	ST-2448-RT	red translucent	6.7	
	<b>24 x 48mm Twofold Tile</b>			
	ST2-2448-GR	gray	6.7	
	ST2-2448-IV	ivory	6.7	
	ST2-2448-GN	green	6.7	
	ST2-2448-CH	charcoal	6.7	
	ST2-2448-BG	beige	6.7	
	ST2-2448-WT	white translucent	6.7	
	<b>48 x 48mm Tile</b>			
	ST-4848-GR	gray	10.6	
	ST-4848-IV	ivory	10.6	
	ST-4848-GN	green	10.6	
	ST-4848-CH	charcoal	10.6	
	ST-4848-BG	beige	10.6	
	ST-4848-WT	white translucent	10.6	
	<b>48 x 48mm Fourfold Tile</b>			
	ST4-4848-GR	gray	10.6	
	ST4-4848-IV	ivory	10.6	
	ST4-4848-GN	green	10.6	
	ST4-4848-CH	charcoal	10.6	
	ST4-4848-BG	beige	10.6	
	ST4-4848-WT	white translucent	10.6	
	<b>48 x 72mm Tile</b>			
	ST-4872-GR	gray		
	ST-4872-IV	ivory		
	ST-4872-GN	green		
	ST-4872-CH	charcoal		
	ST-4872-BG	beige		
	ST-4872-WT	white translucent		

Mosaic System SM24	Mosaic Tiles			
Figure	Part No.	Description	Weight (g)	
	<b>24 x 48mm Tile With One Legend Plate (3mm high)</b>			
	ST-2448-L1-GR	gray		
	ST-2448-L1-IV	ivory		
	ST-2448-L1-GN	green		
	ST-2448-L1-CH	charcoal		
	ST-2448-L1-BG	beige		
	<b>24 x 48mm Tile With Three Legend Plates (3mm high)</b>			
	ST-2448-L3-GR	gray		
	ST-2448-L3-IV	ivory		
	ST-2448-L3-GN	green		
	ST-2448-L3-CH	charcoal		
	ST-2448-L3-BG	beige		
	<b>48 x 48mm Tile With One Legend Plate (9mm high)</b>			
	ST-4848-L1-GR	gray		
	ST-4848-L1-IV	ivory		
	ST-4848-L1-GN	green		
	ST-4848-L1-CH	charcoal		
	ST-4848-L1-BG	beige		
	<b>Legend Plate 3mm high x 42mm long</b>			
	SL-3/42-GR	gray		
	SL-3/42-IV	ivory		
	SL-3/42-GN	green		
	SL-3/42-CH	charcoal		
	SL-3/42-BG	beige		
	<b>Legend Plate 9mm high x 42mm long</b>			
	SL-9/42-GR	gray		
	SL-9/42-IV	ivory		
	SL-9/42-GN	green		
	SL-9/42-CH	charcoal		
	SL-9/42-BG	beige		

Mosaic System SM24	Grid and Front Profiles			
Figure	Part No.	Description	Weight (g)	
	<b>Grid Module 288 x 288mm</b>			
	SG-2412	Straight	882.0	
	<b>Grid Module 288 x 288mm</b>			
	SG-2412C	Curved	882.0	
	<b>Front Aluminum Profile</b>			<b>g/m</b>
	SP-100	15 x 30mm	350.0	
	<b>Front Aluminum Profile</b>			<b>g/m</b>
	SP-200	18 x 40mm	700.0	
	<b>Front Aluminum Profile</b>			<b>g/m</b>
	SP-300-2	18 x 80mm	2020.0	

Mosaic System SM24	Support and Floor Profiles			
Figure	Part No.	Description	Weight (g)	
	<b>Support Profile</b> <span style="float: right;"><b>g/m</b></span>			
	SP-600	24 x 24mm	513.0	
	<b>Support Profile</b> <span style="float: right;"><b>g/m</b></span>			
	SP-700	24 x 48mm	1048.0	
	<b>Support Profile</b> <span style="float: right;"><b>g/m</b></span>			
	SP-800	48 x 48mm	1875.0	
	<b>Support Profile</b> <span style="float: right;"><b>g/m</b></span>			
	SP-900	48 x 72mm	3250.0	
	<b>Floor Profile</b> <span style="float: right;"><b>g/m</b></span>			
	SP-1000	24 x 96mm	2424.0	

Mosaic System SM24	Hardware Accessories				
Figure	Part No.	Description	Weight (g)		
	<b>Grid Attachment</b>				
	SJS-24	Grid Junction Screw Set	1.1		
	<b>Grid to Front Profile Attachment</b>				
	SF-01A	Grid-Profile Fastening Set A	20.6		
	<b>Grid to Front Profile Attachment</b>				
	SF-01B	Grid-Profile Fastening Set B	17.3		
	<b>Grid to Front Profile Attachment</b>				
	SF-01C	Grid-Profile Fastening Set C	6.0		
	<b>Grid to Support Profile Attachment</b>				
	SP-60U	60mm U-shaped bracket	50.0		
	SP-120U	120mm U-shaped bracket			
	<b>Grid to Support Profile Attachment</b>				
	SP-120	120mm	28.0		
	SP-180	180mm	34.0		

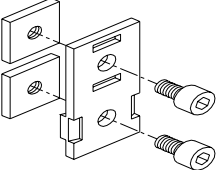
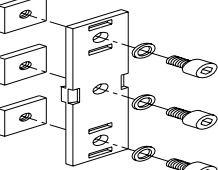
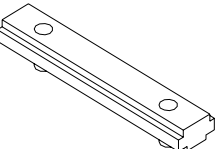
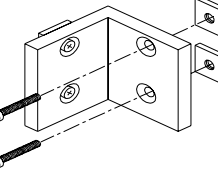
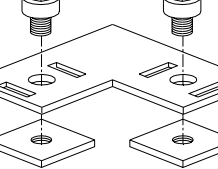
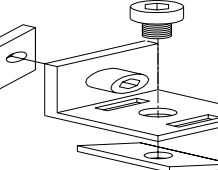
Mosaic System SM24	Hardware Accessories			
Figure	Part No.	Description	Weight (g)	
	<b>T-Connector</b>			
	STC-01	24 x 48mm	51.5	
	<b>Profile Connector</b>			
	SPC-01	For grid support	178.0	
	<b>Profile Connector</b>			
	SIB-01	Interconnecting bar		
	<b>90 Degree Corner Connector</b>			
	SJA-01		16.6	
	<b>90 Degree Profile Joint Connector</b>			
	SJA-03		64.0	
	<b>Gliding Angle Connector</b>			
	SGA-01		52.0	

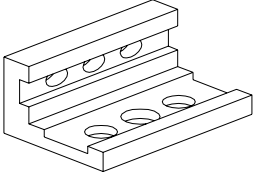
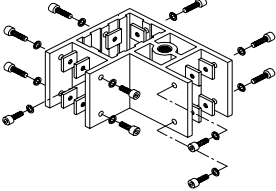
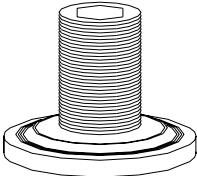
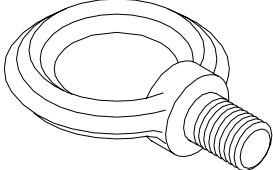
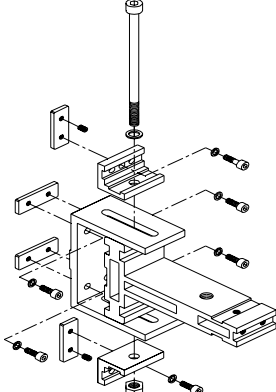
Mosaic System SM24	Hardware Accessories			
Figure	Part No.	Description	Weight (g)	
	<b>Cross Connector</b>			
	SCA-01		44.0	
	<b>Angle Connector</b>			
	SAC-01		1756.0	
	<b>Vertical Adjustment</b>			
	SVA-01	M16	184.0	
	<b>Lifting Eyebolt</b>			
	SLH-01		280.0	
	<b>Grid Support</b>			
	SP-180M	Two-Sided Pillar Fastening	1217.0	

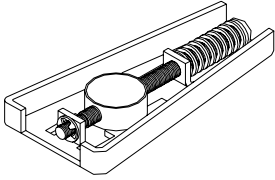
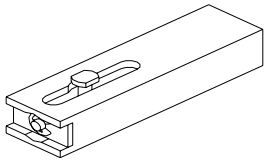
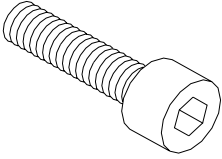
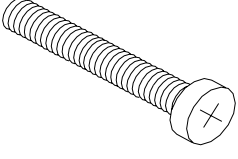
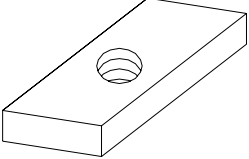
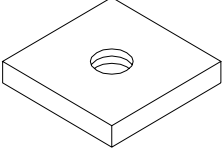
Mosaic System SM24	Hardware Accessories				
Figure	Part No.	Description	Weight (g)		
	<b>Mounting Bracket</b>				
	SPB-01	Front Profile Attachment			
	<b>Mounting Bracket</b>				
	SPB-02	Front profile Attachment			
	<b>Hexagonal Socket Head Bolt</b>				
	SS-612	M6 x 12mm	4.8		
	SS-616	M6 x 16mm	5.7		
	SS-618	M6 x 18mm	5.8		
	SS-625	M6 x 25mm	7.2		
	<b>Cross Recessed Head Screw</b>				
	SCS-304	M3 x 4mm	0.5		
	SCS-320	M3 x 20mm	0.9		
	SCS-520	M5 x 20mm	4.0		
	SCS-535	M5 x 35mm	5.7		
	<b>Oblique Slide Nut</b>				
	SSN-05	M5	6.3		
	SSN-06	M6	5.9		
	SSN-08	M8	5.3		
	<b>Square Slide Nut</b>				
	SSNS-05	M5	7.0		
	SSNS-06	M6	8.8		

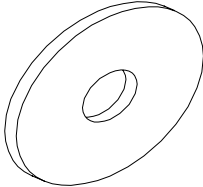
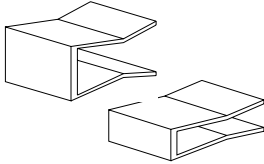
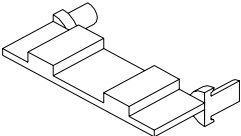
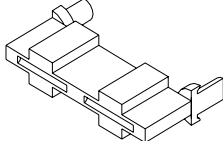
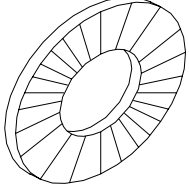
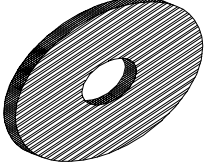
Mosaic System SM24	Hardware Accessories			
Figure	Part No.	Description	Weight (g)	
	<b>Nylon Washer</b>			
	<b>Tile Clip</b>			
	SC-01	Single	0.1	
	SC-02	Double	0.1	
	<b>Instrument Spacer</b>			
	SIS-01	8mm one-sided	0.5	
	<b>Instrument Spacer</b>			
	SIS-02	8mm two-sided	0.5	
	<b>Ribbed Lock Washer</b>			
	SLW-06	M6	0.4	
	<b>Washer, Zinc Plated Steel</b>			
	SPW-01	Washer for Pillar	0.4	
	SRW-05	M5	0.4	
	SRW-06	M6	0.4	